

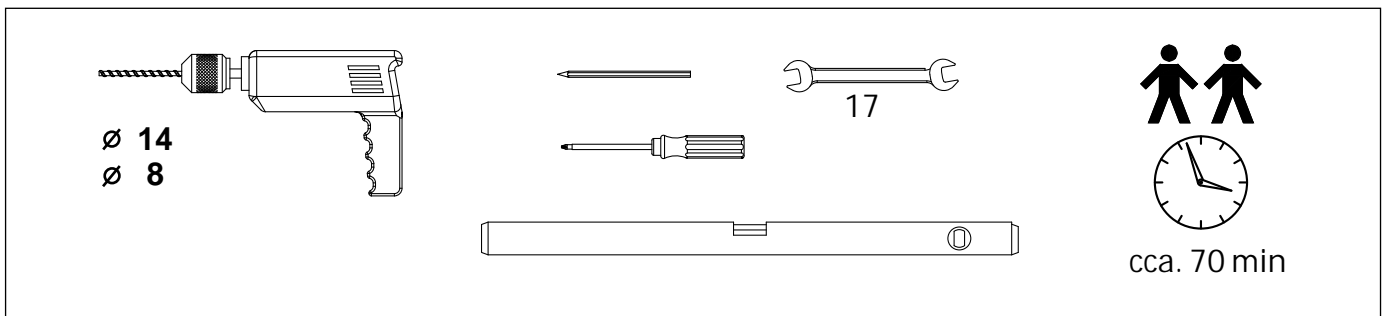

St íšky - markýzy hloubky 950 mm s akrylátovou krytinou tl. 4 mm

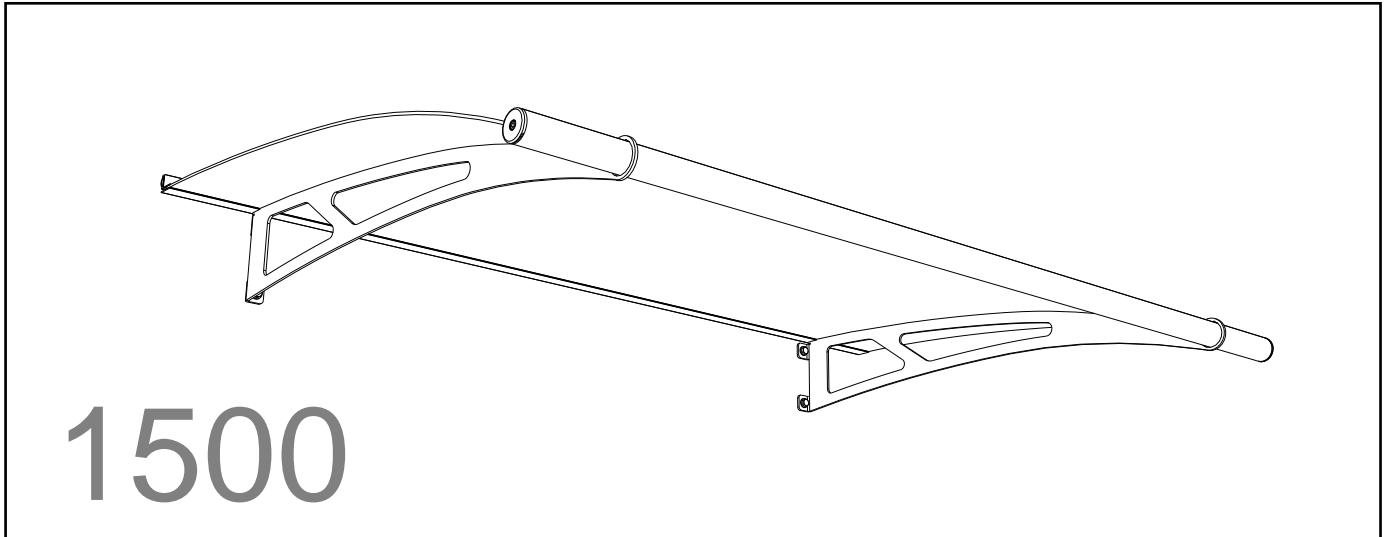

Upozorn ní:

P ed montáží je třeba provést kontrolu zdiva a p ípadn použít alternativní ukotvení do zdi. Šrouby a hmoždinky, které jsou sou ástí montážní sady nemusí být vhodné pro kotvení do r zných typ zdí (duté cihly, tepelná izolace apod.).



Pokyny pro íšt ní:



Pro akrylátové sklo nepoužívejte ístící prostředky obsahující edidlo nebo prostředky na drhnutí. Používejte jen jemný mýdlový roztok nebo speciální ístící prostředky a m kku, nedrhnoucí tkaninu. Pro nerezovou ocel doporu ujeme Lightline shine konzervaci (170993).

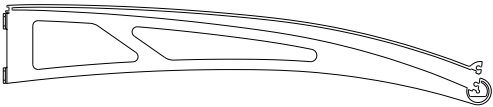
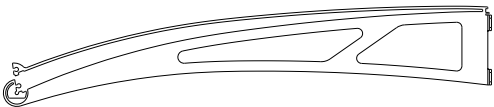

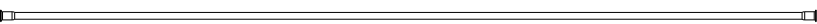

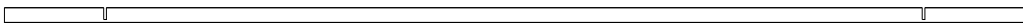

A  1500mm x 950mm x 4mm 1x



B  1x  1x

D   1x

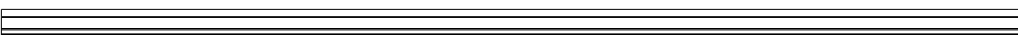
E   1x

F   1x

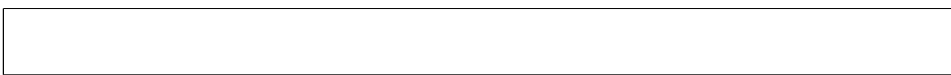
G   1x

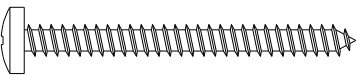
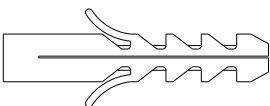

H   2x

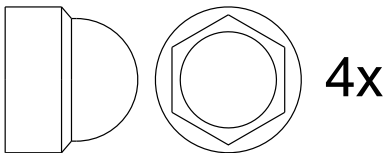
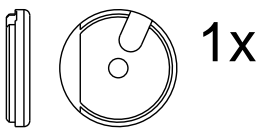
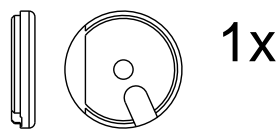
I   4x

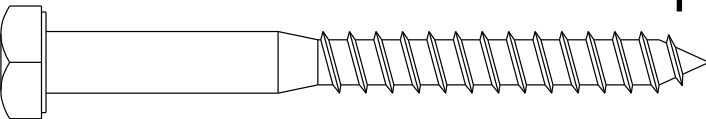
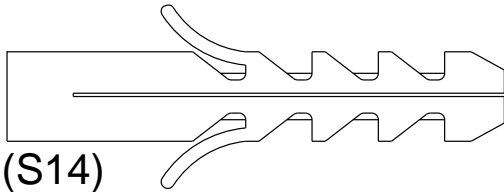
K  4x L  4x M levá  1x N pravá  1x

O  (DIN 571 10x100) P  4x

 2x

T   2x

