

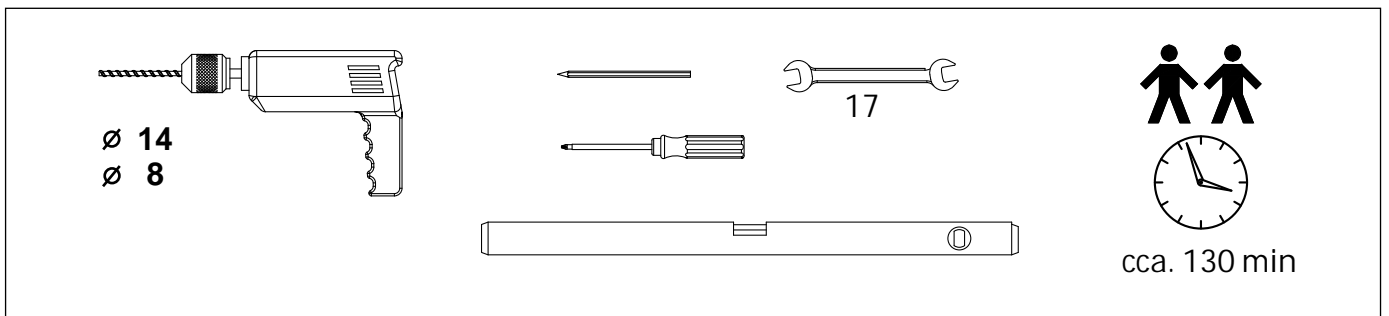

St íšky - markýzy hloubky 950 mm s akrylátovou krytinou tl. 4 mm

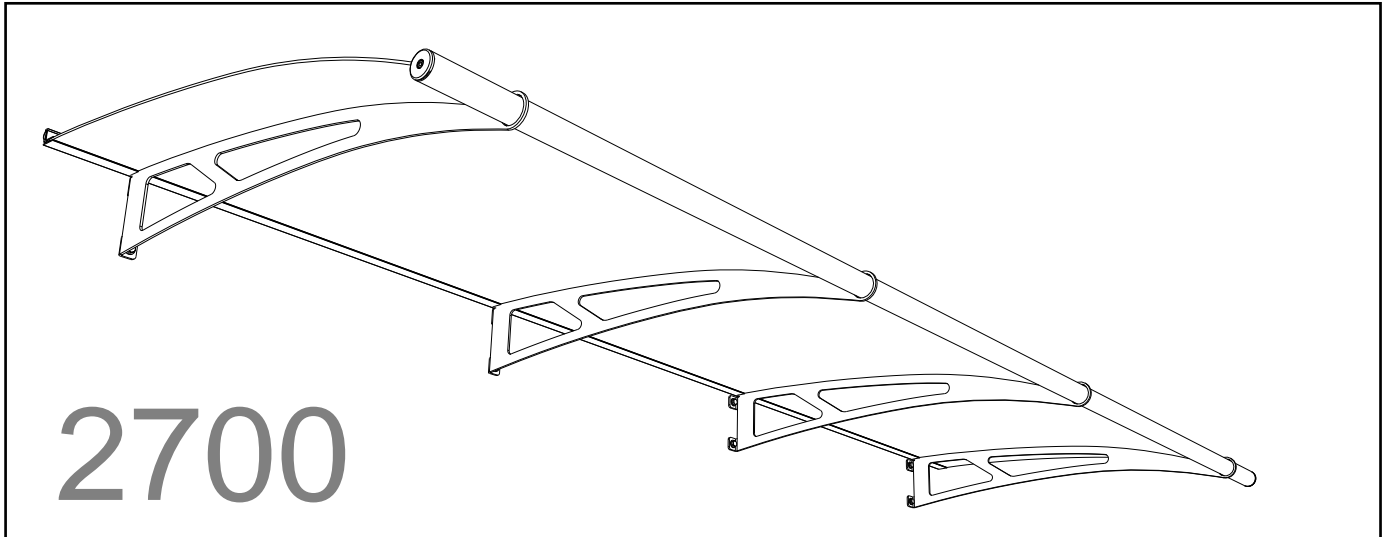

Upozorn ní:

P ed montáží je třeba provést kontrolu zdiva a p ípadn použít alternativní ukotvení do zdi. Šrouby a hmoždinky, které jsou sou ástí montážní sady nemusí být vhodné pro kotvení do r zných typ zdí (duté cihly, tepelná izolace apod.).



Pokyny pro íšt ní:



Pro akrylátové sklo nepoužívejte ístící prostředky obsahující edidlo nebo prostředky na drhnutí. Používejte jen jemný mýdlový roztok nebo speciální ístící prostředky a m kku, nedrhnoucí tkaninu. Pro nerezovou ocel doporu ujeme Lightline shine konzervaci (170993).

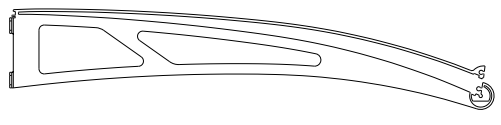
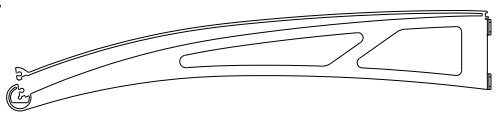



A  2700mm x 950mm x 4mm 1x



B  2x C  2x

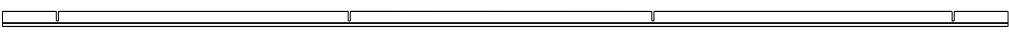

D   1x

E   2x

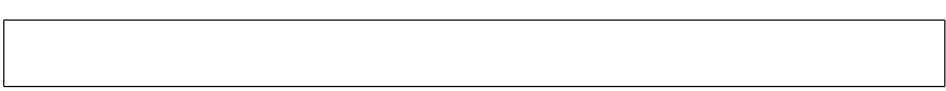

F   1x

G   1x

H   1x

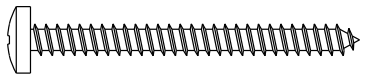
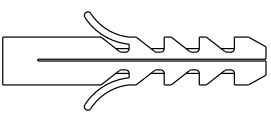
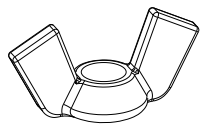

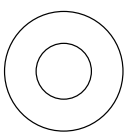
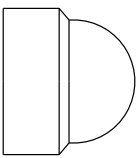
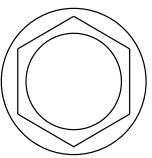
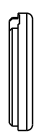
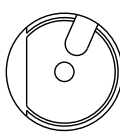
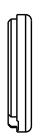
I   2x

J  K  4x L  1x

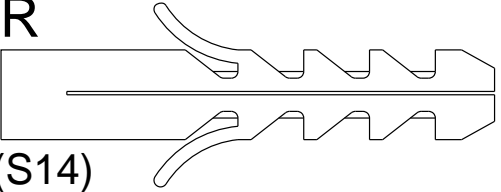
M  8x N   8x  levá  1x  pravá  1x

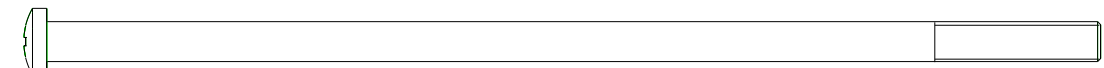
Q  (DIN 571 10x100) R  (S14) 8x

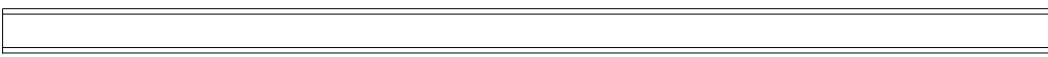
S  2x

T   4x

