

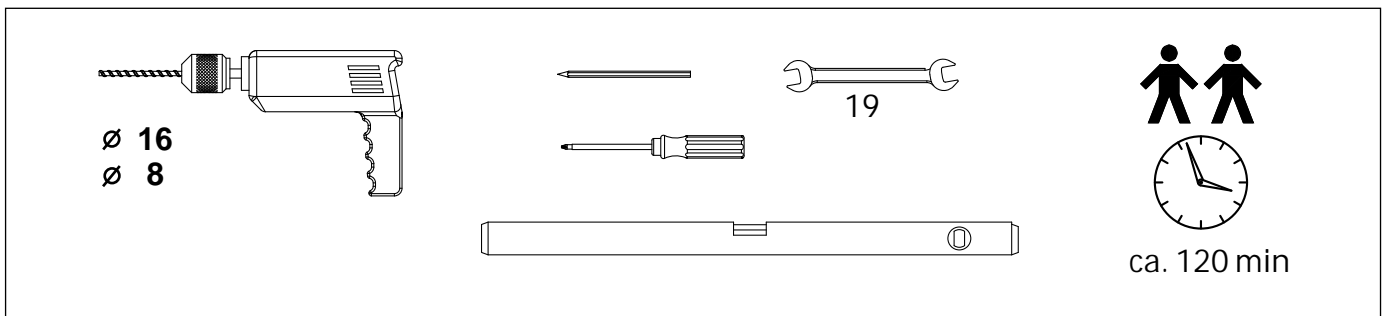

St íšky - markýzy hloubky 1420 mm s akrylátovou krytinou tl. 6 mm

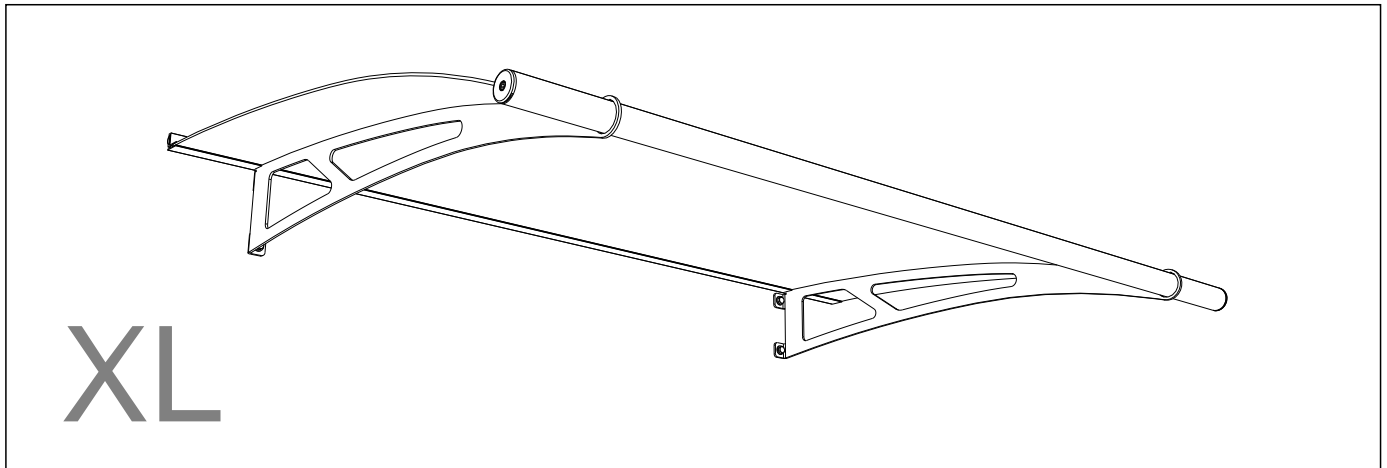

Upozorn ní:

P ed montáží je třeba provést kontrolu zdiva a p ípadn použít alternativní ukotvení do zdi. Šrouby a hmoždinky, které jsou sou ástí montážní sady nemusí být vhodné pro kotvení do r zných typ zdí (duté cihly, tepelná izolace apod.).



Pokyny pro íšt ní:



Pro akrylátové sklo nepoužívejte ístící prostředky obsahující edidlo nebo prostředky na drhnutí. Používejte jen jemný mýdlový roztok nebo speciální ístící prostředky a m kku, nedrhnoucí tkaninu. Pro nerezovou ocel doporu ujeme Lightline shine konzervaci (170993).

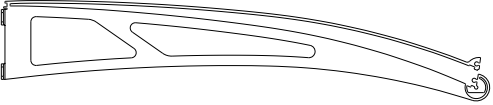
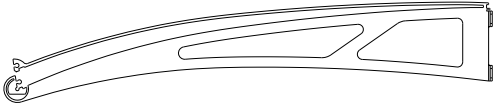

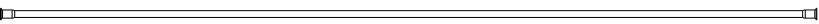

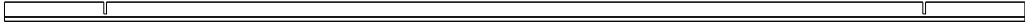

A  2050mm x 1420mm x 4mm 1x



B  1x  1x

D   1x



E   1x

F   1x

G   1x

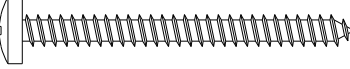
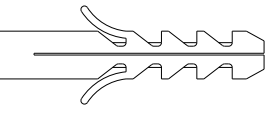
H   2x

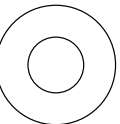
I   4x

K   4x

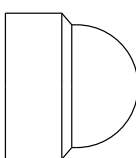
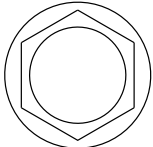
L   4x

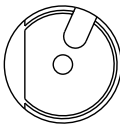

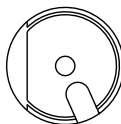
M pravá   1x

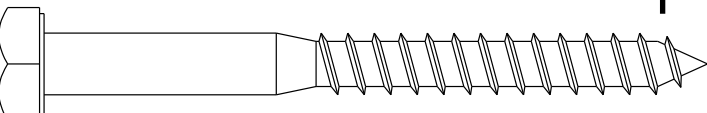
N levá   1x

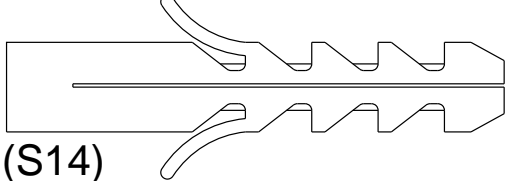
O  (DIN 571 10x100)

P  (S14) 4x

 2x

T   2x

